

DACHFIRST ÜBERGREIFENDE DACHFLÄCHEN

DACHNEIGUNG $< 30^\circ$
 $\cong 25^\circ$

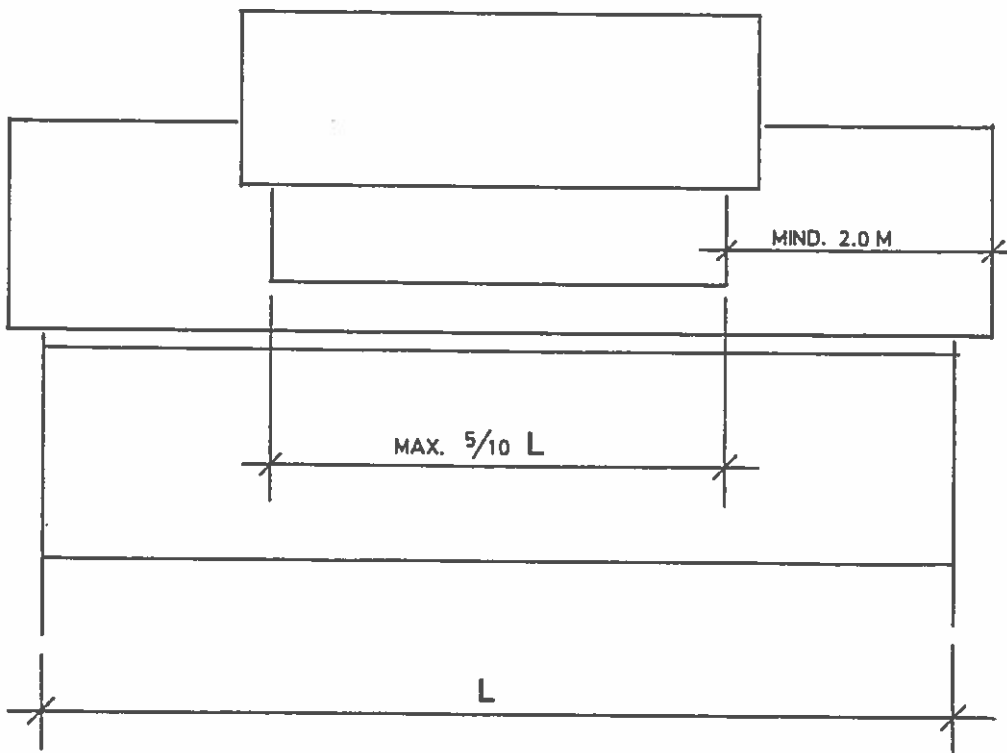
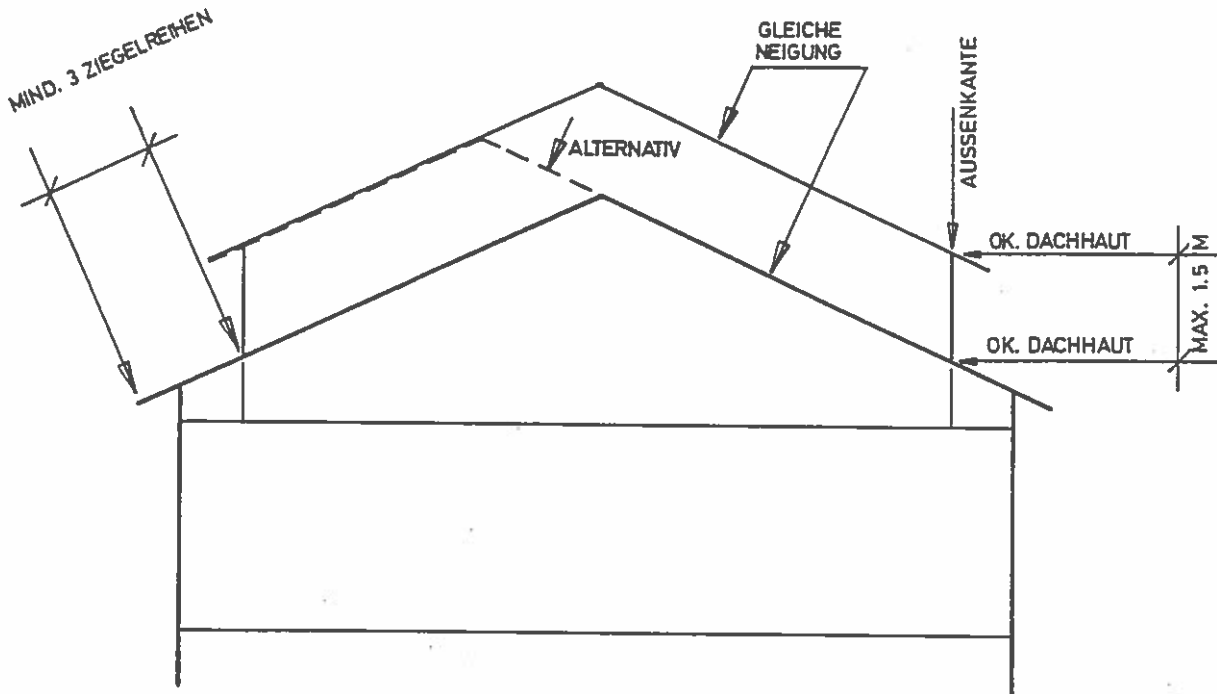

DACHNEIGUNG $< 30^\circ$
 $\cong 25^\circ$

ZWERCHGIEBEL/-HÄUSER
 DACHGAUPEN

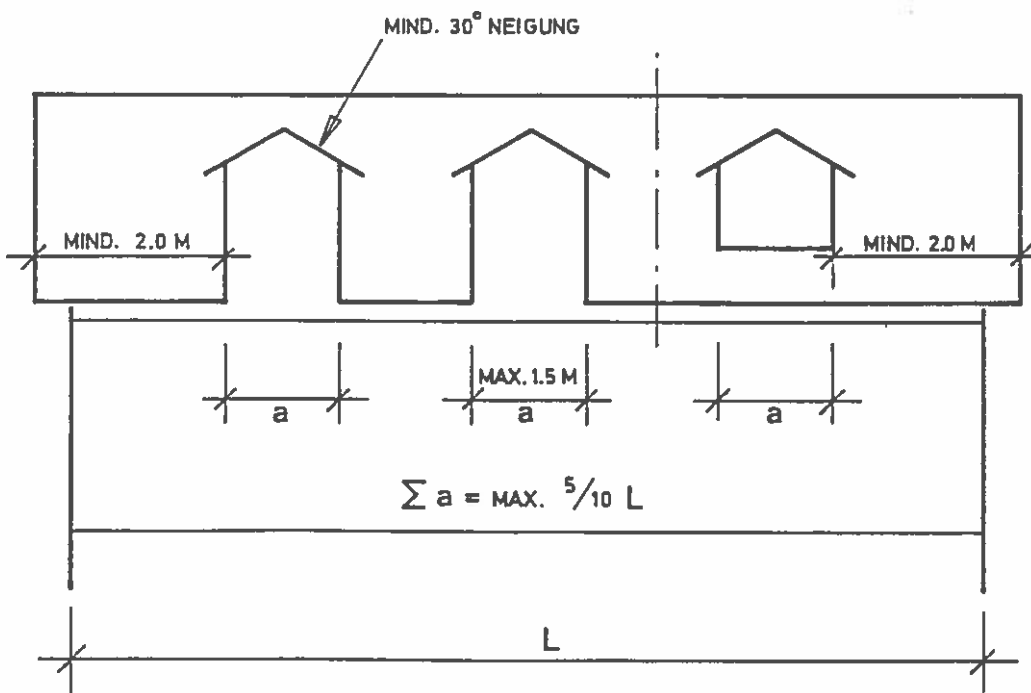
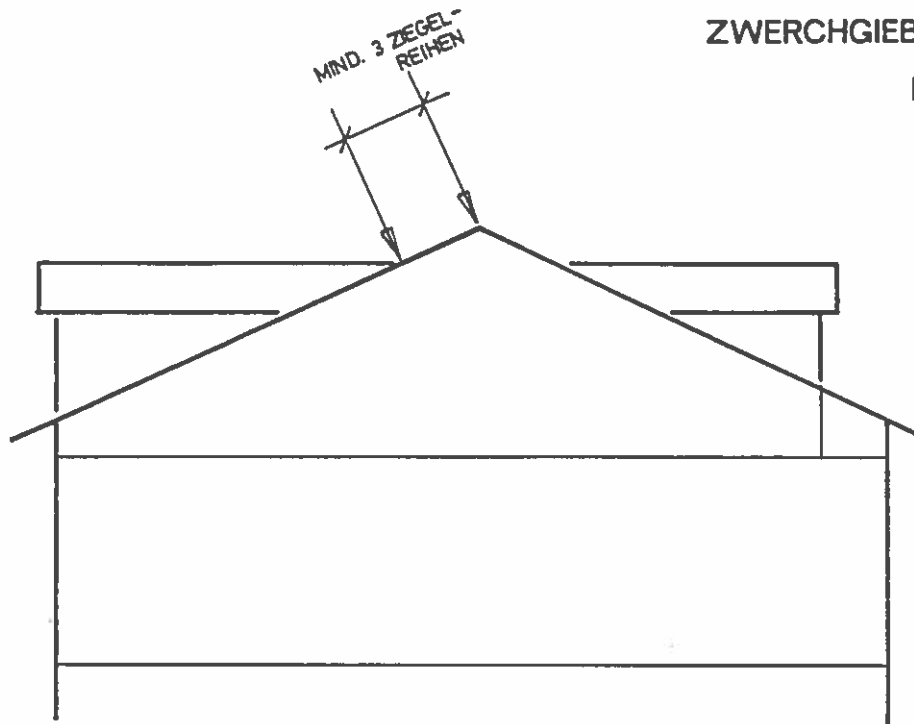

DACHNEIGUNG > 30°

DACHFIRST ÜBERGREIFENDE DACHFLÄCHEN

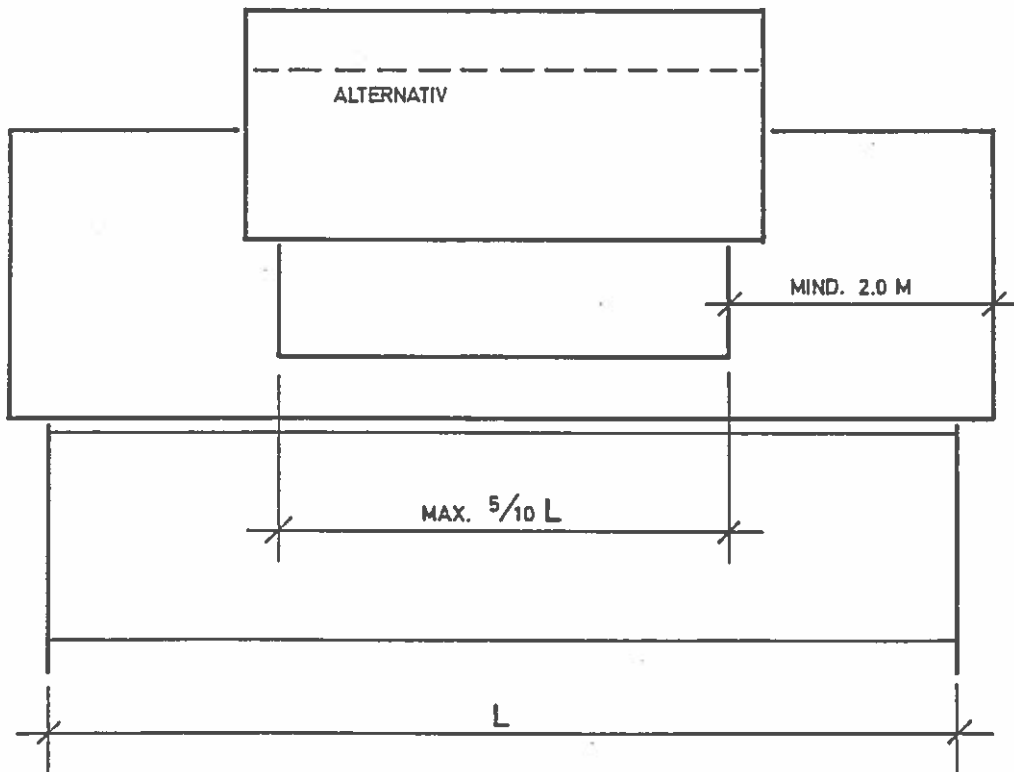
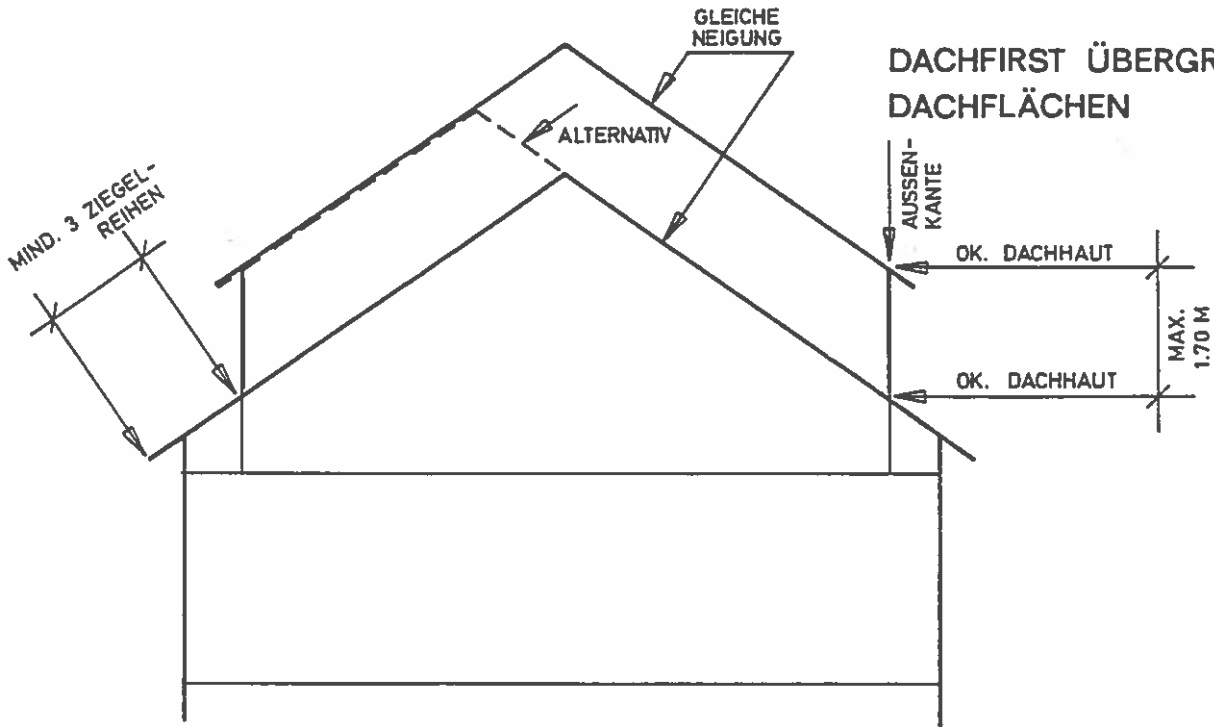

DACHNEIGUNG $> 30^\circ$

DACHGAUPE

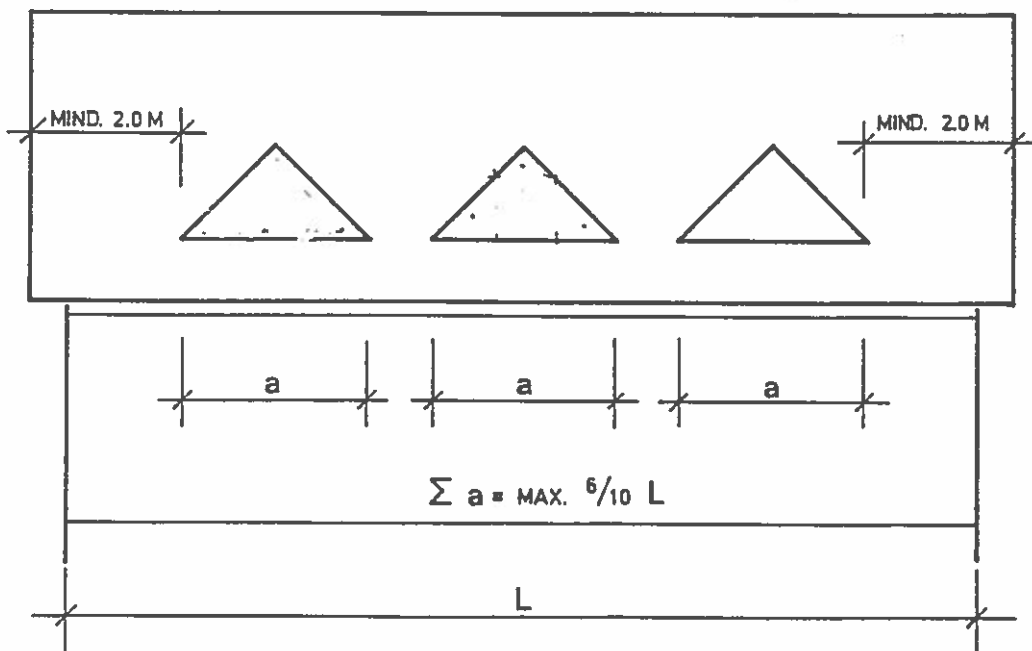
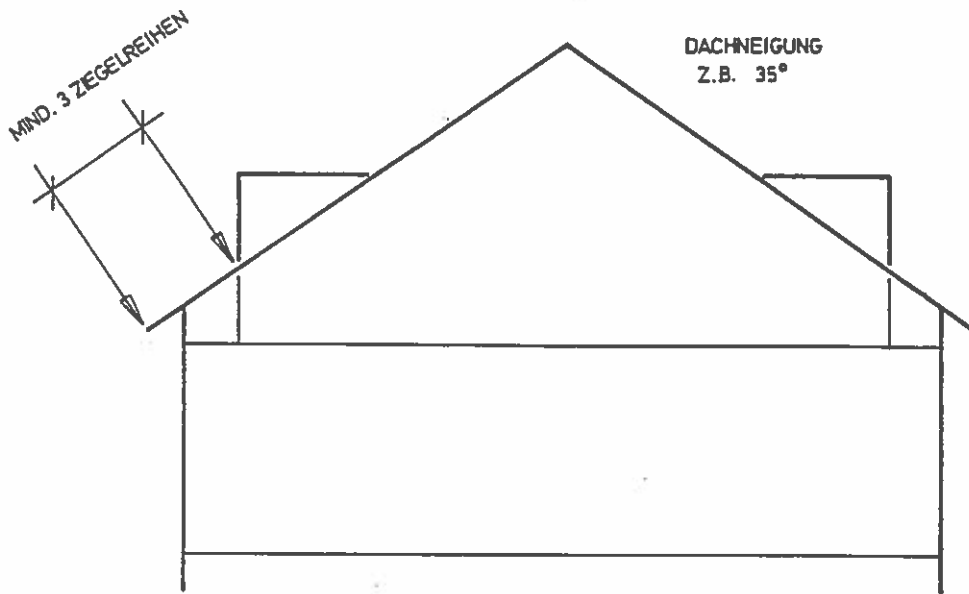

DACHNEIGUNG >30°

ZWERCHGIEBEL / -HÄUSER

DACHGAUPEN

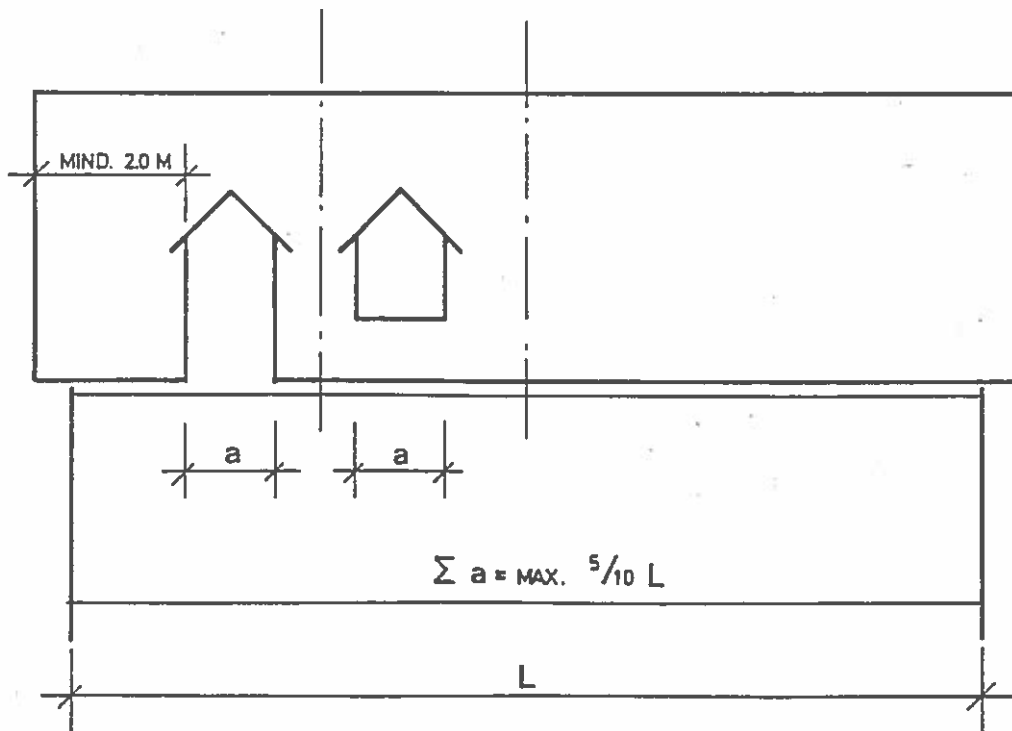
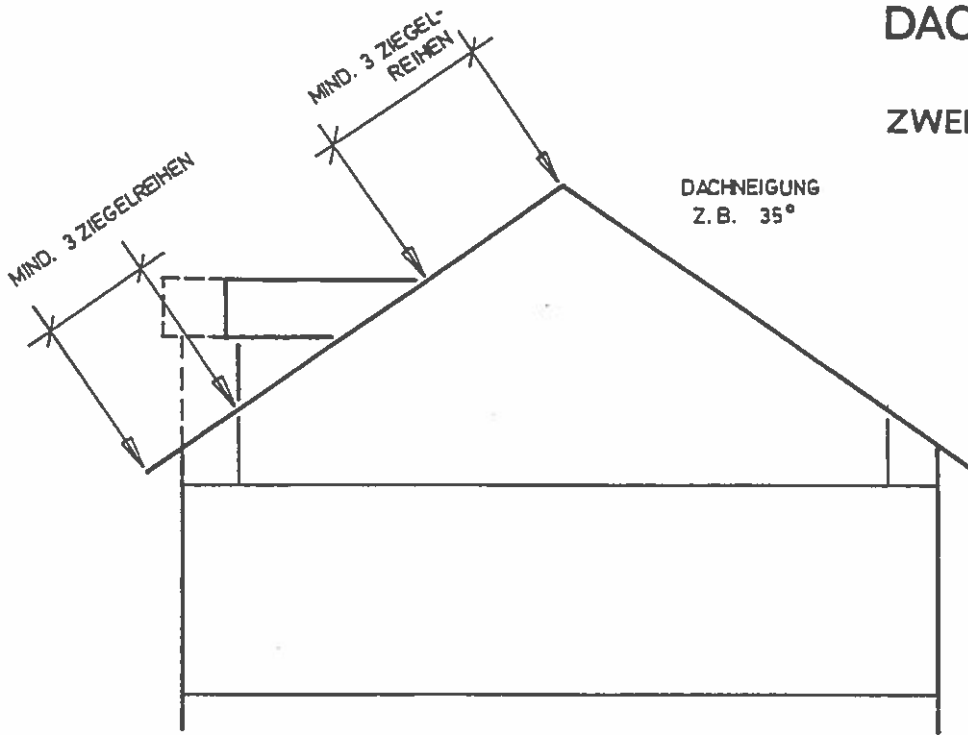

DACHNEIGUNG $> 30^\circ$

